



MedMolds
Plastic Components for Medical Devices



**COMPONENTS
CATALOGUE**
www.medmolds.com





MedMolds
Plastic Components for Medical Devices



*Quality is never an accident; it is always
the result of high intention, sincere effort,
intelligent direction and skillfull execution;
it represents the wise choice of many
alternatives.*

W.A Foster

www.medmolds.com

GUIDE WIRE HOLDERS

TOUHY BORST ADAPTERS

1cm
2cm
3cm
4cm
5cm
6cm
7cm
8cm
9cm
10cm
11cm
12cm
13cm
14cm
15cm
16cm

1cm
2cm
3cm
4cm
5cm
6cm
7cm
8cm
9cm
10cm
11cm
12cm
13cm
14cm
15cm
16cm

10370



10380



10430



10340



10362



10210



10220



10355



10335



10330



1cm
2cm
3cm
4cm
5cm
6cm
7cm
8cm
9cm
10cm
11cm
12cm
13cm
14cm
15cm
16cm

1cm
2cm
3cm
4cm
5cm
6cm
7cm
8cm
9cm
10cm
11cm
12cm
13cm
14cm
15cm
16cm

10490



10495



10440



10480



10570



10580



10595



10590



PINCH / CLICK CLAMPS

1cm
2cm
3cm
4cm
5cm
6cm
7cm
8cm
9cm
10cm
11cm
12cm
13cm
14cm
15cm
16cm

15114



15110



15112



15150

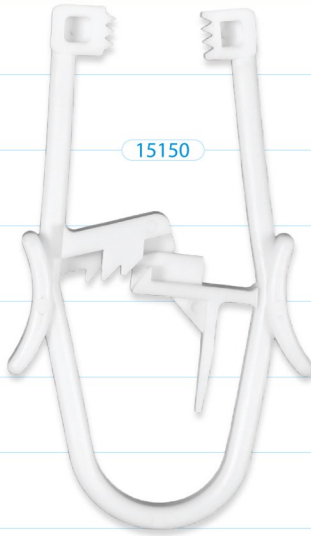

15120



15140



SIDE CLAMPS

1cm
2cm
3cm
4cm
5cm
6cm
7cm
8cm
9cm
10cm
11cm
12cm
13cm
14cm
15cm
16cm

25130



25135



25140



25145

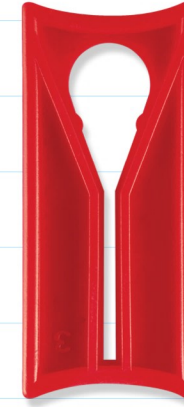

25125



25110



25122



25120



MALE LUER CONNECTORS

FEMALE LUER CONNECTORS

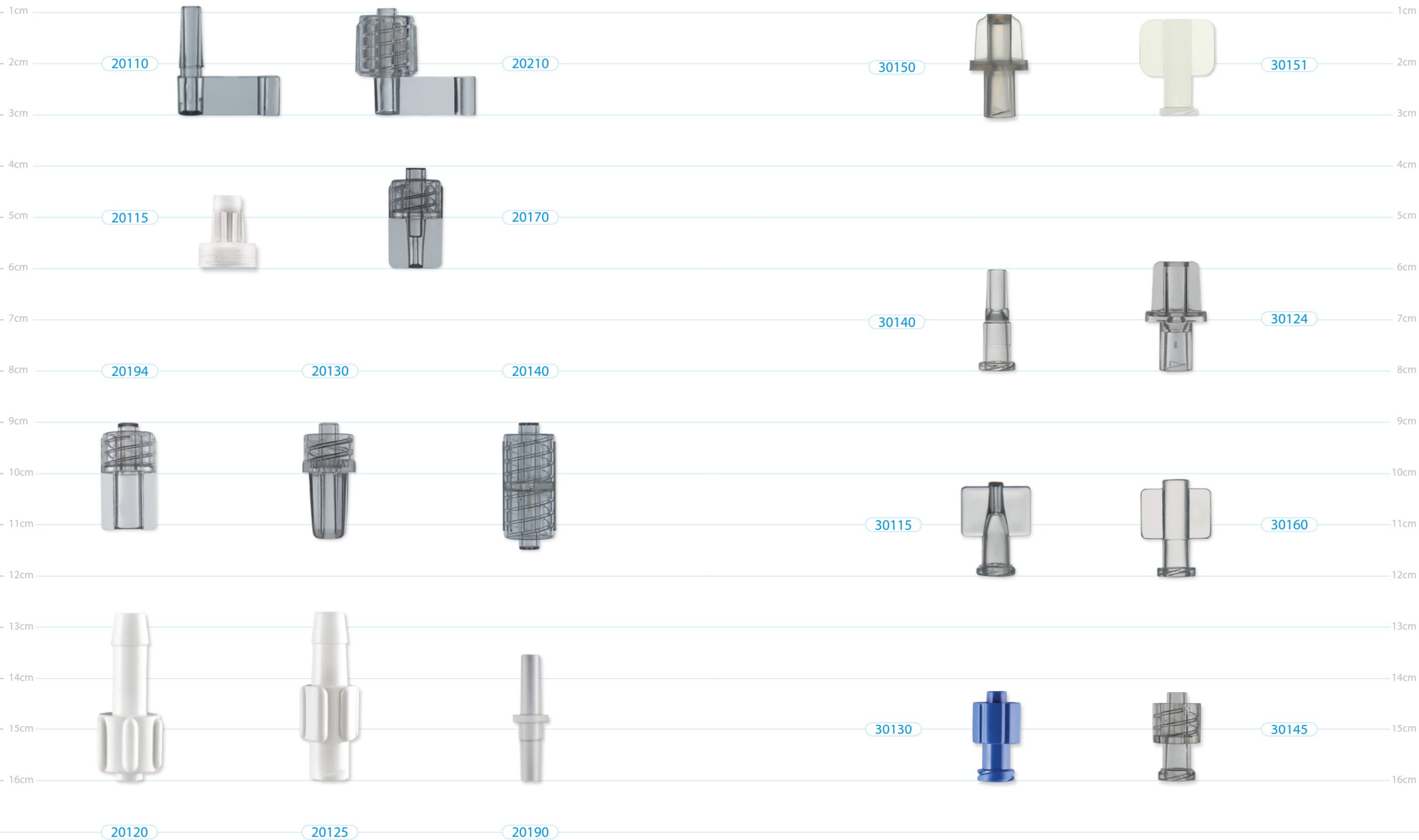

1cm
2cm
3cm
4cm
5cm
6cm
7cm
8cm
9cm
10cm
11cm
12cm
13cm
14cm
15cm
16cm

40410

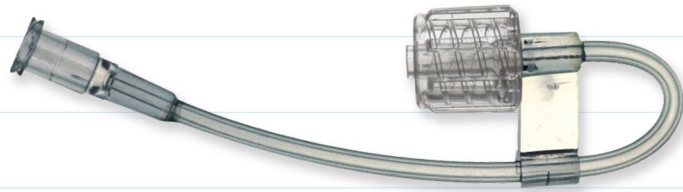

1cm
2cm
3cm
4cm
5cm
6cm
7cm
8cm
9cm
10cm
11cm
12cm
13cm
14cm
15cm
16cm

40510



40600

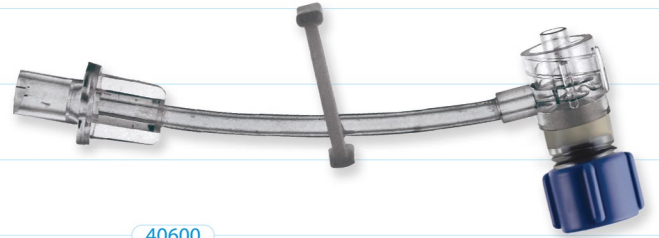

40812

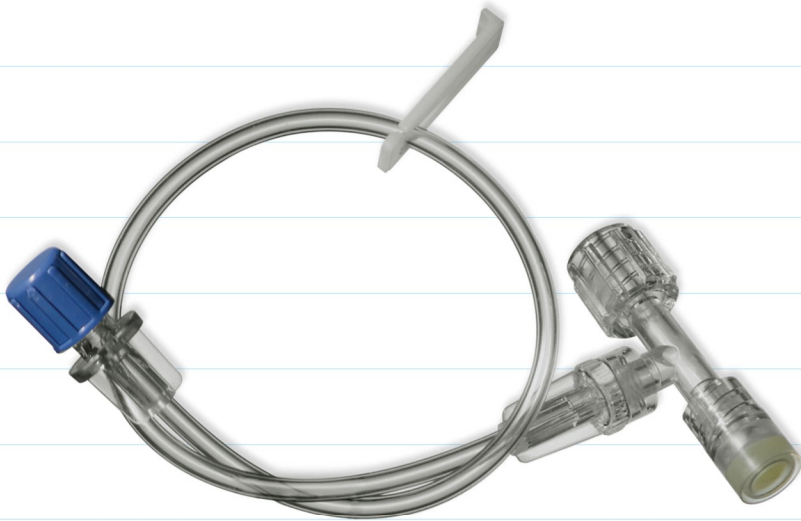

40810



HAEMOSTASIS & CHECK VALVES

BOTTLES AND SPOONS

1cm
2cm
3cm
4cm
5cm
6cm
7cm
8cm
9cm
10cm
11cm
12cm
13cm
14cm
15cm
16cm

1cm
2cm
3cm
4cm
5cm
6cm
7cm
8cm
9cm
10cm
11cm
12cm
13cm
14cm
15cm
16cm

90310



90320



40740



40720



45150

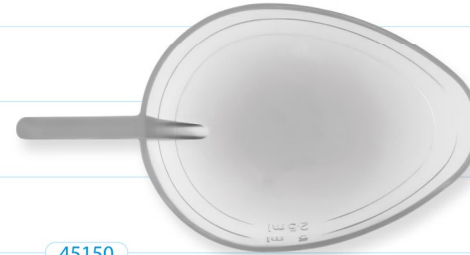

45130



45470



45460



ROLLER CLAMPS

DRIP CHAMBERS

1cm
2cm
3cm
4cm
5cm
6cm
7cm
8cm
9cm
10cm
11cm
12cm
13cm
14cm
15cm
16cm

1cm
2cm
3cm
4cm
5cm
6cm
7cm
8cm
9cm
10cm
11cm
12cm
13cm
14cm
15cm
16cm

50210



50220



50230



50235

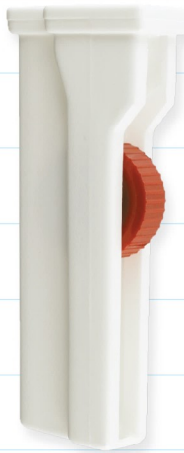

55210



55310



1cm
2cm
3cm
4cm
5cm
6cm
7cm
8cm
9cm
10cm
11cm
12cm
13cm
14cm
15cm
16cm

1cm
2cm
3cm
4cm
5cm
6cm
7cm
8cm
9cm
10cm
11cm
12cm
13cm
14cm
15cm
16cm

55160

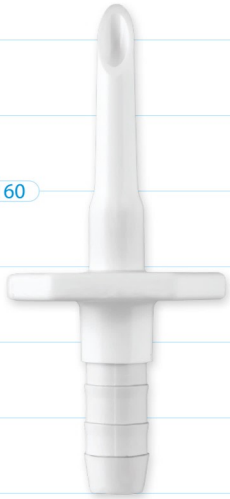

55155

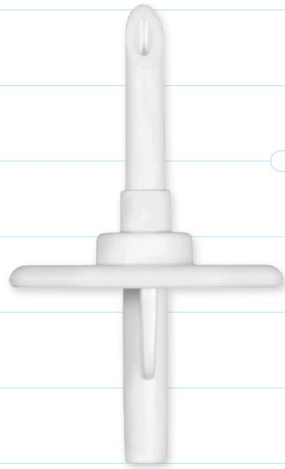

55150

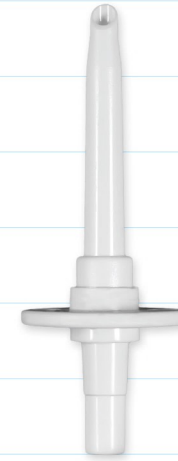

55130



55140



55110

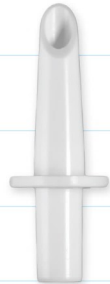

55111



55170



CUSTOM ITEMS

1cm

60118



601128
Custom Item

2cm

3cm

4cm

5cm

6cm

7cm

8cm

9cm

10cm

11cm

12cm

13cm

14cm

15cm

16cm



90181



601108



601106



60156



60154

CUSTOM ITEMS

1cm



60140

2cm

3cm

4cm

5cm

6cm

7cm

8cm

9cm

10cm

11cm

12cm

13cm

14cm

15cm

16cm



60127



60128



60130



60115



60135



60180



60120



60190

CUSTOM ITEMS

CUSTOM ITEMS

1cm
2cm
3cm
4cm
5cm
6cm
7cm
8cm
9cm
10cm
11cm
12cm
13cm
14cm
15cm
16cm

1cm
2cm
3cm
4cm
5cm
6cm
7cm
8cm
9cm
10cm
11cm
12cm
13cm
14cm
15cm
16cm

60182



60152

60158



60160



60320

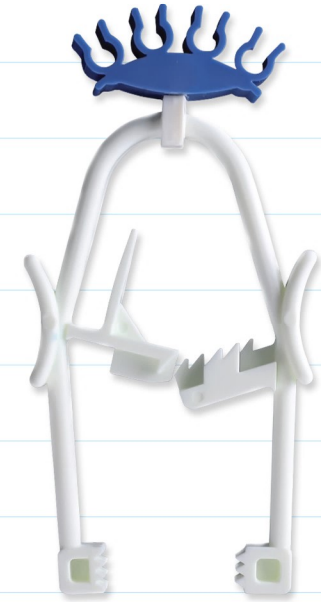

60330



60171



60122

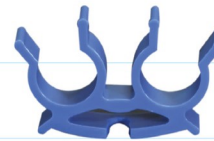

60121



60123



MISCELLANEOUS



40118



40114



40117



40116



40320

T - CONNECTORS



70410



70105



70102



70110



70210

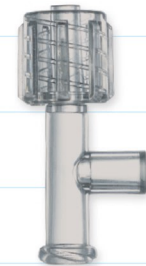

70220

HAND PUMPS



85510

85520

HAND PUMPS & END CAPS



85320

85310

85710

85210

85220

1cm
2cm
3cm
4cm
5cm
6cm
7cm
8cm
9cm
10cm
11cm
12cm
13cm
14cm
15cm
16cm

1cm
2cm
3cm
4cm
5cm
6cm
7cm
8cm
9cm
10cm
11cm
12cm
13cm
14cm
15cm
16cm



90110



90120



90160



90140



90130



90150



90180



90114



90135



90170



90185



90175

MULTI TUBING CONNECTORS

Y - CONNECTORS

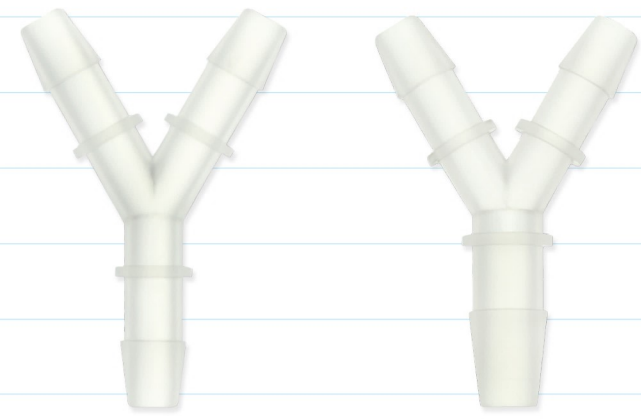

COMPONENTS DETAIL

P/N	Component	Description	Material
GUIDE WIRE HOLDERS			
10210	Guide Wire Holder	For guide wire OD 0.029" ~ 0.038"	PP- HDPE
10220	Guide Wire Holder	For guide wire OD 0.048" ~ 0.058"	PP
10370	Guide Wire Holder	Brass collet ID 0.038"	PC
10380	Guide Wire Holder	Brass collet ID 0.038"	ABS-HDPE
TOUHY BORST ADAPTERS			
10320	TBA Female	Gasket ID 0.045", 3 Fr	PC-ABS-Silicon
10325	TBA Female	Gasket ID 0.035"	PC-Silicon
10330	TBA Female	Gasket ID 0.035"	PC-ABS-Silicon
10335	TBA Female	Gasket ID 0.035"	PC-ABS-Silicon
10340	TBA Male Luer	Gasket ID 0.118", 9 Fr	PC-ABS-Silicon
10350	TBA Male Luer	Gasket ID 0.032"	PC-ABS-Silicon
10355	TBA Male-Female Luer	Gasket ID 0.035"	PC-ABS-Silicon
10360	TBA Male Luer	Gasket ID 0.060", 4 Fr	PC-ABS-Silicon
10362	TBA Male Luer, Side Port	Gasket ID 0.032", side port ID 3.0mm	PC-ABS-Silicon
10415	TBA Male Luer, Rotating	Gasket ID 0.032"	PC-ABS-Silicon
10430	TBA Male Luer, Rotating	Gasket ID 0.060", 4 Fr	PC-ABS-Silicon
10435	TBA Male Luer, Rotating	Gasket ID 0.118", 9 Fr	PC-ABS-Silicon
10440	TBA Small	6-17 Fr, red	PC-Silicon
10480	TBA Male Luer, Rotating	Gasket ID 0.118", 9 Fr	PC-Silicon
10490	TBA Large Bore	0-13 Fr, blue	PC-Silicon
10495	TBA Large Bore	6-17 Fr, red	PC-Silicon
10570	TBA Large Bore, Side Port	0-13 Fr, blue, side port ID 5.0mm	PC-Silicon
10580	TBA Large Bore, Side Port	6-17 Fr, red, side port ID 5.0mm	PC-Silicon
10590	TBA Large Bore/FLL	0-13 Fr, blue	PC-Silicon
10595	TBA Large Bore/FLL	6-17 Fr, red	PC-Silicon
PINCH / CLICK CLAMPS			
15110	Click Clamp, small	2.0mm OD tubing	Acetal
15112	Click Clamp, small	2.0mm OD tubing	Acetal-Blue
15114	Click Clamp, small	2.0mm OD tubing	Acetal-Red
15120	Click Clamp # 2	2.0~4.0mm OD tubing	PP
15140	Click Clamp	4.0~6.5 mm OD tubing	PP
15150	Towel Clamp	Press lock, 1"	ABS
SIDE CLAMPS			
25110	Side Clamp	3.5mm OD tubing, slit	HIPS- Natural
25120	Side Clamp	3.5mm OD tubing	HDPE- White
25122	Side Clamp	3.5mm OD tubing	HDPE- Orange
25125	Side Clamp	4.5mm OD tubing	HDPE- Orange
25130	Side Clamp	6mm OD tubing	HDPE- White
25135	Side Clamp	6mm OD tubing	HDPE- Red
25140	Side Clamp	10mm OD tubing	HDPE- White
25145	Side Clamp	10mm OD tubing	HDPE- Red

MLS = Male Luer Slip MLL = Male Luer lock FLL = Female Luer Lock MLLR = Male Luer Lock Rotating

COMPONENTS DETAIL

P/N	Component	Description	Material
MALE LUER CONNECTORS			
20110	Tubing Connector MLS, J-loop	Tubing port ID 2.6mm	PC
20112	Tubing Connector MLS, J-loop	Tubing port ID 2.0mm	PC
20114	Tubing Connector MLS, J-loop	Tubing port ID 4.1 mm	PC
20115	Cap for MLL	Vented	LDPE
20120	Barbed Tubing Connector, male	Tubing ID 6~7mm	ABS
20125	Barbed Tubing Connector, female	Tubing ID 6~7mm	ABS
20130	Tubing Connector MLL	Tubing port ID 3.2mm, four wings	PC
20135	Tubing Connector MLL	Tubing port ID 3.2mm, four wings	ABS Clear
20140	Connector Double Male Luer	0.090" thru hole	PC
20150	Connector Microbore MLL	Tubing port ID 0.029"	PC
20170	Connector Microbore MLL	Tubing Port ID 0.035"	PC
20180	Connector Microbore MLL	Tubing port ID 0.056"	PC
20190	Adapter MLS	Tubing port ID/OD 2.3/4.0mm	PP
20192	Male Luer Tubing Connector	Tubing port ID 5.6 mm	PC
20193	Male Luer Tubing Connector	Tubing port ID 5.0 mm	PC
20194	Male Luer Tubing Connector	Tubing port ID 4.1 mm	PC
20198	Male Luer Tubing Connector	Tubing port ID 3.0 mm	PC
20210	Tubing Connector~MLLR, J-loop	Tubing port ID 2.6 mm	PC
20212	Tubing Connector~MLLR, J-loop	Tubing port ID 2.0 mm	PC
FEMALE LUER CONNECTORS			
30122	FLL Tubing Connector, wings	Tubing port ID 3.0 mm	PC
30124	FLL Tubing Connector, wings	Tubing port ID 4.1 mm	PC
30126	FLL Tubing Connector, wings	Tubing port ID 5.0 mm	PC
30115	FLL Connector, microbore	Tubing port ID 0.058"	PC
30130	Male /Female Connector	Standard MLL /FLL	ABS - Blue
30135	Male /Female Connector	Standard MLL /FLL	ABS - White
30140	FLL (w/o wing)	Tubing port ID 2.6mm	PC
30141	FLL (w/o wing)	Tubing port ID 2.0mm	PC
30145	Male /Female Connector	Standard MLL/FLL	PC
30150	Female L /Lock Cap to dead-end	Dead-ender with FLL	PP
30151	Female L /Lock Cap to dead-end	Dead-ender with FLL	HDPE
30160	Female Lure Tubing Connector	Tubing port ID 0.166"	PC
30162	Female Lure Tubing Connector	Tubing port ID 4.1 mm	ABS
30164	FLL Connector, wide-wings	Tubing port ID 3.0 mm	PC
30170	FLL Connector, micro-bore	Tubing port ID 0.029"	PC
30190	FLL Connector, micro-bore	Tubing port ID 0.035"	PC
CUSTOM KITS / ASSEMBLIES			
40410	J-Loop Connecting Set	MLLR x 100mm tubing x FLL	PC-PVC
40510	T- Connector Assembly	Tube 1.75" x OD 0.129" x FLL x side clamp	PC- HIPS-PVC
40600	TBA side port with tubing	Tube 2.0" x OD 0.129" with FLL	PC-ABS-PVC-HDPE
40810	TBA Navigator Assembly	Tube 1.75" x OD 0.129" x FLL x side clamp x TBA male 0.032"	PC-HIPS-PVC-ABS
40812	T-Inj Port + Assembly + Ext Tube	Tube 8" x OD 0.129" x FLL x side clamp x injection site	PC-HIPS-PVC-HDPE

MLS = Male Luer Slip MLL = Male Luer lock FLL = Female Luer Lock MLLR = Male Luer Lock Rotating

COMPONENTS DETAIL

P/N	Component	Description	Material
HEMOSTASIS AND CHECK VALVES			
40720	Hemostasis Valve Y-Connector	With push and pull function, 0-7 Fr	PC
40740	Hemostasis Valve Y-Connector	With push and pull function, 0-7 Fr	PC - Gamma
90310	Check Valve	In line check valve for 3.5mm OD tubing	ABS-PC
90320	Check Valve	Tubing port ID 6.5mm, high flow check valve	ABS - Clear-Blue
BOTTLES AND SPOONS			
45130	Spoon, Measuring	5ml, with slit handle	PP-White
45150	Spoon, Measuring	2.5ml & 5.0ml marking	PP - Clear
45460	HDPE Bottle with CRC	27mm dia, 60ml, natural	HDPE-PP
45470	HDPE Bottle with CRC	27mm dia, 100ml, natural	HDPE-PP
ROLLER CLAMPS			
50210	Roller Clamp	3.5mm OD tubing	HIPS-PP
50220	Roller Clamp	4.5mm OD tubing	HDPE-ABS
50230	Roller Clamp	6.5mm OD tubing	ABS-PP
50232	Roller Clamp	6.5mm OD tubing, click	ABS-PP
50235	Roller Clamp	4.5mm OD tubing	HDPE-ABS
DRIP CHAMBERS			
55210	Drip Chamber and Cap	6.5mm OD tubing	ABS - PVC
55310	Drip Chamber + Spike + Cover	Tubing port Ø 3.5mm	ABS - PVC - PP
SPIKES AND COVERS			
55101	Syringe Cap	Standard female	PC
55110	Mini Spike	Tubing port 5.0/6.0mm (ID/OD)	ABS
55111	IV Spike to fit chamber	ID 14.5mm, 15 drops/ml	ABS
55130	Cap for IV Spike	ID 7.4 , vented	PP
55140	Cap for Mini Spike	ID 6.5, vented	PP
55150	Spike Irrigation	6.5mm OD tubing	ABS
55155	Spike with wings	ID/OD 4.3/5.7mm tubing port	ABS
55160	Barb Spike	To fit tubing ID 1/4"	ABS
55170	Spike, Blood	Tubing port OD 4.5mm	ABS
CUSTOM ITEMS			
60109	Anal Probe Adapter	OD tubing 2.0 mm	Hytrel
60115	Straight Tube, small	Barbed OD 8.2mm	PP
60118	Seat Adapter Base for Ball Valve	OD tubing 5.5 mm	ABS - Clear
60120	Connector FL, wings	10 Fr tubing	PC - Yellow
60121	Single Wire Clip for Easy Lead	Wire clip to hold single wire	PC - ABS
60122	2 Wire Clip for Easy Lead	Wire clip to hold 2 wires	PC - ABS
60123	3 Wire Clip for Easy Lead	Wire clip to hold 3 wires	PC - ABS
60125	Connector FL, wings	7 Fr, tubing	PC - Yellow
60127	Restrictor Casing 1	Tubing port ID: 2.75 mm	ABS
60128	Restrictor Casing 2	1 RML	ABS
60130	Barbed Connector	9 Fr	TPU(TEXIN)
60135	FLL Connector, Butterfly	Tubing port ID 0.03"	PC

COMPONENTS DETAIL

P/N	Component	Description	Material
60140	Teether Cap	MLL with teether cap	HDPE-Blue
60142	Hemo Cap	Snap fit, 9 Fr	ABS
60152	Hepparine Clip, Large	Large clip green PMS 242242	LDPE - Green
60154	Nozzle Straight	83mm x 6.3mm tube, straight	LDPE
60156	Nozzle, Curved	78mm x 6.3mm dia tube, curved	LDPE
60158	2 Wire Clip	Wire clip to hold 2 wires OD 2.5 mm	ABS
60160	4 Wire Clip	Wire clip to hold 4 wires OD 2.5 mm	ABS
60171	Female Tubing Connector	TP ID 1.5/0.8mm with standard FLL	PC
60172	Female Tubing Connector	TP ID 2.3/1.6mm with standard FLL	PC
60180	Double Tubing Connector	To fit tubing OD 4.1mm	PC
60182	Tubing Connector	Tubing Port OD 8/14 mm	PC
60190	Tube Holder, Double	3 & 6mm OD tubing	ABS
60192	Teether Cap	MLL with teether cap	HDPE-White
60320	EasyLead	Towel clamp, swivel, 4 wire curve clip with wire holder	PC - ABS
60330	Control Knob	Aluminum insert and set screw	ABS
60350	Guide Wire Collet	ID 1.27 mm	ABS - Orange-White
601106	Tube Clamp	-	ABS
601108	Tube Clamp	For tube OD 4mm and OD 4.5mm	ABS
601128	Tubing Clip	For tubing OD 4mm and OD 5.85mm	PP-Red
MISCELLANEOUS			
40110	Measuring Saucer	2.5ml - 5ml	PP
40112	Measuring Cup, 15ml	Marking 5ml, 10ml and 15ml	GPPS
40114	J Straightener	ID 0.044" for guidewire	ABS
40116	Cap for J straightener	Cap to fit J-Straightener (P/N 40114)	HDPE
40117	Cap for J straightener	Cap to fit J-Straightener (P/N 40118)	HDPE - Orange
40118	J Straightener	ID 0.044" for guidewire	ABS - Blue
40120	Silicon Gasket, Large Bore	0~13 Fr	Silicon
40125	Silicon Gasket, Large Bore	6~17 Fr	Silicon
40130	Silicon Gasket, Female	ID 0.045"	Silicon
40135	Silicon Gasket, Female	ID 0.035"	Silicon
40140	Silicon Gasket, Male	ID 0.032"	Silicon
40142	Silicon Gasket, Check Valve	For high flow valve P/N: 90320	Silicon
40145	Silicon Gasket, Male	ID 0.060"	Silicon
40210	BagPort	ID 6.50mm, OD 7.0 mm (tear-off seal)	PVC
40310	Disposable Plastic Forceps	Wide grip occluding with aluminium rivet	Nylon- Blue
40312	Disposable Plastic Forceps	Wide grip occluding with aluminium rivet	Nylon- Green
40314	Disposable Plastic Forceps	Wide grip occluding with aluminium rivet	Nylon- Yellow
40320	Disposable Plastic Forceps	Wide grip occluding with aluminium rivet	Nylon- Red
T - CONNECTORS			
70105	T - Connector for P/N: 70220	ID 2.4 mm/ OD 4.1 mm, TP ID 3.2 mm	PC
70110	T - Connector	1 MLS x 2 FLL	PC
70210	T - Connector	1 RML x 2 FLL	PC
70220	T - Connector	1 RML x 1 FLL x 0.129" tubing port	PC

COMPONENTS DETAIL

P/N	Component	Description	Material
70260	T-Connector	1FLL x 1RML x 1 relief valve port	PC-Gamma
70410	Stopcock, 3-way	1MLR x 2FLL, blue	PC/HDPE

HAND PUMPS AND END CAPS

85210	End Cap, Inflow	Ø 4.1/8.0mm, blue ball	PVC-PP
85220	End Cap, Outflow	Ø 4.1/8.0mm, white ball	PVC-PP
85230	End Cap, Inflow, Stepped	Ø 4.3 / 7.2mm, blue ball	PVC-PP
85240	End Cap, Outflow, Stepped	Ø 4.3 / 7.2mm, white ball	PVC-PP
85310	End Cap, Inflow with Connector	Ø 6.7 / 9.8mm, blue ball	PVC-PP
85320	End Cap, Outflow with Connector	Ø 6.7 / 9.8mm, white ball	PVC-PP
85510	Hand Pump	Ø 4.1/8.0mm ID/OD tubing port	PVC-PP
85520	Hand Pump, Stepped	Ø 4.1/7.2mm ID/OD tubing port	PVC-PP
85710	Hand Pump with connector	Tubing OD 6.7mm (inside fit)	PVC-PP

MULTI TUBING CONNECTORS

90110	Multi Tubing Connector	OD 8~11mm	ABS
90114	Stepped Connector	For 11.3 mm OD tubing	ABS-Clear
90116	Stepped Connector	For 9.5 mm OD tubing	ABS-Clear
90118	Dual Tubing Connector	To fit OD tubing 5mm and barbed ID 2mm	ABS-Clear
90120	Multi Tubing Connector	OD 10~13mm	ABS
90126	Elbow	Tubing port ID/OD 22/22.5mm	PP
90130	Cap for Multi Connector	ID 10.0 x 45mm length (for P/N 90140-50)	LDPE
90135	Connector for End Cap	Tubing port ID (inside fit) 8.2x6.7mm	PVC
90140	Multi Connector	Ø 6 - 10mm, TP OD 6mm (cap P/N 90130)	ABS
90150	Multi Connector	Ø 7 - 10mm, TP OD 6mm (cap P/N 90130)	ABS
90156	Cardio Y- Connector	Tubing port 1/4" x 1/2" x 1/2"	PC
90160	Barbed Connector	OD 7~11mm	PP
90165	Tube Stopper	1" tube stopper	PP
90170	Y- Connector	Ø 6.7mm ID x 3 ports	PVC
90175	Tubing Connector, Barbed	Tubing port ID/OD 6.5/8.4 mm	ABS
90180	Tubing connector, Barbed	Tubing Port ID 4.0mm, barb end 5.4mm	PC
90181	Reducer Connector	ID 5mm x 7.5mm, barb OD 6.7mm x 9.5mm	ABS
90183	Suction Connector	20 Fr	PVC
90184	Suction Connector	10 Fr	PVC
90185	Step Connector	Tubing port ID/OD = 3.8/5.3mm	ABS
90186	Tubing Connector with FLL	1/4" x 1/4" with FLL	PC
601110	Double Tube Connector	For tube OD 2mm	PC

Y - CONNECTORS

90199	Y- Connector	Tubing port 3/16" x 3/16" x 3/16"	PP
90197	Reducer, Y-Connector	Tubing port 1/4" x 3/16" x 3/16"	PP
90198	Y- Connector	Tubing port 1/4" x 1/4" x 1/4"	PP
90196	Reducer, Y- Connector	Tubing port 5/16" x 1/4" x 1/4"	PP

